



# The **N610i** digital label press

High print quality at flexo speeds



Combines the productivity of flexo  
with the flexibility of digital



Domino. Do more.

# The smarter way to print labels

For label printers, the Domino **N610i**, with up to seven colors including opaque white, 600dpi 'native' print resolution and operating speeds up to 70m/min (230ft/min) combines the productivity of flexo printing with the flexibility offered by rapid job change digital technology.

This means an investment that provides added potential for greater sales growth and increased profitability, whilst reducing production cost and complexity.

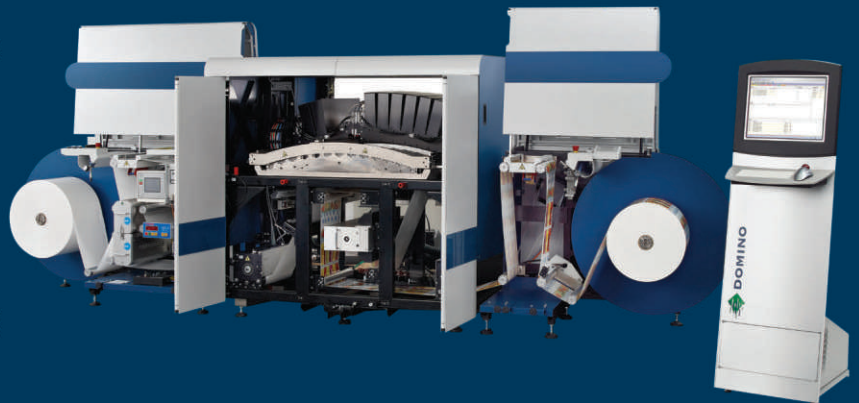

## Applications

The **N610i** uses vibrant UV curable inks designed for a range of industry standard self-adhesive label substrates including coated paper, polypropylene, polyethylene and now also for shrink sleeves.

Ideal for:

Industrial, home, personal care, security, health and safety, automotive, chemical, pharmaceutical, food and beverage sectors\*



\*Subject to an effective migration barrier being in place.

## Raf Joos

CEO, ASQ Labels, Belgium

"It is the quality of the print, the cooperation with the people and the service that we receive from our partner, as that is how we see Domino. We are capable of entering markets for which I'm 100% convinced we would not have reached if we would not have bought the Domino **N610i**."



<http://bit.ly/2gL6UaS>





# The highest digital productivity

## Production capacity

With a 1m (40") diameter roll unwind capable of handling up to 340mm (13.4") wide media and the widest print width (333mm or 13.11") of any Kyocera print head based label press, the **N610i** can process up to 3000 linear metres (9842 linear feet) or 1000m<sup>2</sup> (10764 ft<sup>2</sup>) of material per hour in high quality mode.

## Waste saving

The Domino **i-Tech WebRev** manages substrate type changes and unplanned stoppages through a web reverse function.

For these events, even with in-line finishing, web waste can be limited to less than 2m (6ft) and manual intervention minimised.

## Printing at speed

The High Quality mode can print up to 92% of Pantone colors plus high opacity white at 50m/min (164ft/min). In Rapid Mode, the **N610i** is capable of printing at 70m/min (230ft/min) with optimised performance and will still accurately reproduce up to 90% of the Pantone range, delivering unparalleled levels of quality and performance.



## Dave Ferguson

President, McCourt Label, USA

"Scrap and labour savings, since moving this job to the Domino, is huge. With the Domino we can run in ONE HOUR what we used to run in an entire shift on flexo. We have only been running it for one month and we have already seen an increase in sales because of the Domino **N610i**."



<http://bit.ly/2vOPMv8>

# The best inkjet print quality

## It's not just about resolution

Even though Domino uses high resolution print heads from Kyocera at 600dpi, delivering more dots per inch than many competitive systems, this alone does not deliver the best inkjet quality. To achieve this, print head integration, precise web transport, robust components i.e. Corona and UV, bespoke workflow and the highest quality inks are all essential to ensure the best print results.





# The most reliable digital solution

## It's just so simple

Inkjet technology is non-contact, with few moving parts, no printing plates, no drums, no blankets and no complex maintenance programmes. The time to change from printing one job to another is instantaneous with practically no substrate waste.



## Jets that keep jetting

Domino's quality controlled UV inks are constantly circulated around the print head by the innovative **i-Tech ActiFlow** ink circulation system, even when printing has stopped. **ActiFlow** degasses the ink, preventing air bubbles forming, which can impact nozzle performance.

## Automated maintenance

The revolutionary **i-Tech CleanCap** automated print head cleaning and capping technology is a consistently controlled process which reduces manual operator intervention meaning that daily manual head wiping is now a thing of the past!

## Ink circulates in every part of the white ink system to provide the ultimate reliability

Domino **i-Tech UltraMix™** ink tank continuously circulates the white ink ensuring the pigment does not settle, but stays in suspension at all times, providing consistent results and enhanced reliability.

The Domino heavily pigmented **i-Tech TrapLess™** print bar has a unique design removing all potential ink traps where pigment can conglomerate. This helps to avoid the risk of early life nozzle failure that would impact print quality and reliability.



Domino **N610i** White **i-Tech UltraMix™** Ink Tank

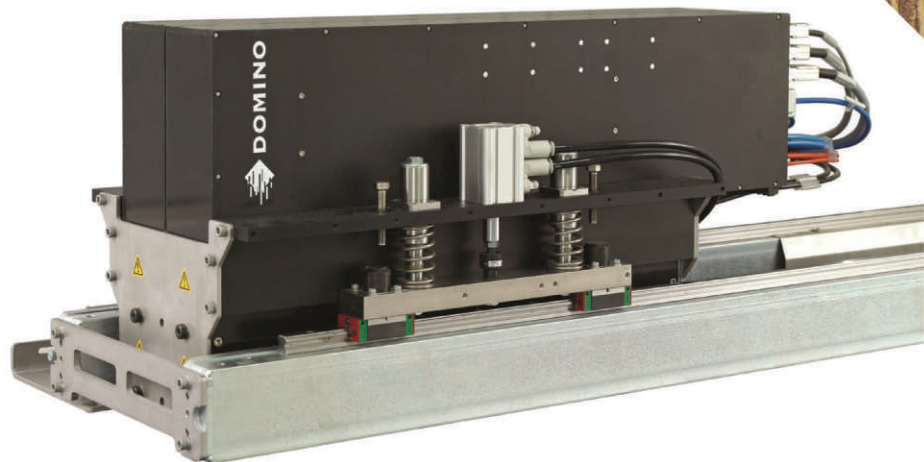

Domino **N610i** White **i-Tech TrapLess™** Print Bar



# Highest opacity digital white

The **N610i** White provides the highest opacity (at 72%) screen-like, high-impact appearance, but with the operational flexibility of a digital process.

## Silk screen-like printing replacement with a difference

There are no screens to be produced in order to get that opaque bold two-dimensional textured effect typically only possible with screen printing technology. **N610i** White is clean to operate with almost no maintenance, efficiently providing this high impact printing in any quantities with no waste or time required to change from printing one job to another.



## Make your labels stand out from the crowd

- ◆ **Add value** - Offer premium product branding with enhanced shelf appeal
- ◆ **Competitive advantage** - Win additional business based on unique textured printing capability
- ◆ **Creative designs** - Endless textured designs on part or all of the label
- ◆ **Cost-effective** - Can be used as a replacement for screen printing or as a substitute for premium textured substrates
- ◆ **Personalisation** - Combine with variable data printing for completely unique product offerings

## Raf Joos

CEO, ASQ Labels, Belgium

"It is a very opaque white – it looks like it's been screen printed. That was the moment we were won over by the Domino **N610i**."



<http://bit.ly/2gL6Ua5>

## Textures by Domino

Increased shelf edge appeal is achieved due to the highly reflective nature of the print. Unique digital textured effects can open up new applications for Domino

**N610i** press owners.

Unique textured label printing is achieved at speeds up to 50m/min (164ft/min). This feature can also be used to substitute premium priced textured substrates with Domino's textured print on standard paper, PP and PE materials.

# Textures by Domino

# Domino UV90 and UV95 Ink Sets

Designed to deliver the widest gamut whilst also delivering the key mechanical features and benefits of inkjet over toner based digital printing technologies. Provides superior adhesion with unparalleled resistance to heat & cold, sunlight, chemical and saline attack and abrasion to maintain the highest quality through the life of the final product.

## Our color range

In today's fast evolving retail marketplace, the importance of color in product packaging cannot be over-emphasised. The **N610i** provides brand owners and designers the scope to create designs with a far wider color gamut cost-effectively.

Our seven color press can achieve in excess of 92% of the Pantone® color range without the need to make plates or the complexity of mixing spot colors.



UV95 Color Gamut

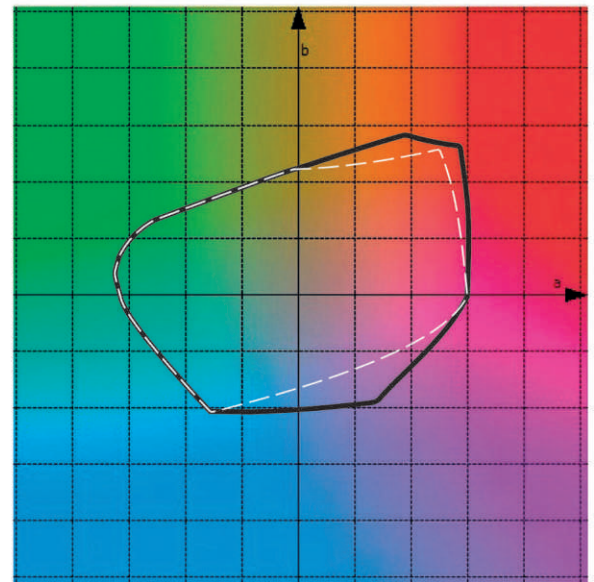

White dashed - standard gamut (CMYK)  
Black - extended gamut (CMYKOV)

## Shrink Sleeves

This removes the need to use traditional flexographic printing processes, with the associated high waste costs and long set-up times and offers a much more cost effective solution for medium length production than slow speed toner.

Domino's high performance ink is the only high-speed UV ink set solution capable of maintaining full adhesion after the heat-sensitive shrink labelling substrate has been shrunk to its maximum level, often down to 35% or less of its original size.





## Lightfastness

This is a property of the ink colorants that describes how permanent, and thus resistant to fading, they are when exposed to UV radiation. Lightfastness indicates the suitability of the ink to be used in different applications, with those aimed for outdoors use and long-term direct sun exposure requiring very good resistance to fading and higher level of the lightfastness.

Measured using the Blue Wool Scale, a widely adopted standard used to express the lightfastness of pigments and dyes, the Domino **UV90** ink set achieves the highest possible score of eight across a range of substrates, offering the maximum resistance to fade within the industry.

SUBSTRATE	UV90WT	UV90YL	UV90OR	UV90MG	UV90VL	UV90CY	UV90BK
PP Top White	8	8	8	8	8	8	8
PE 85 TC	8	8	8	7/8	8	8	8
MC Primecoat	7/8	8	8	6	8	8	8

SUBSTRATE	UV95WT	UV95YL	UV95OR	UV95MG	UV95VL	UV95CY	UV95BK
PP Top White	N/A	6	8	6	8	7/8	6
PE 85 TC	8	6	8	6	8	7/8	6
MC Primecoat	N/A	6	7/8	6	7/8	6	6

Provides high resistance to:

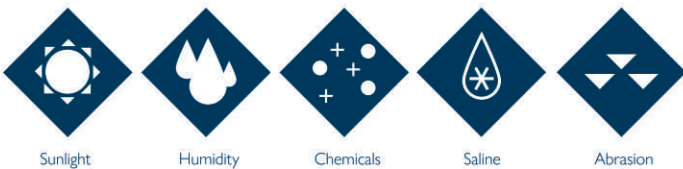

## Adhesion & Abrasion

Although vital for industrial applications, adhesion and abrasion are important for all printing applications to ensure the finished goods survive the journey to the shelf in optimum condition and then offer the longest possible shelf life.

Tested using the industry standard cross hatch and tape tests, the Domino **UV90** and **UV95** inks maintain full adhesion on the widest range of substrates and remain highly abrasion resistant to maximise shelf appeal. This degree of adhesion removes the need to pre-coat or varnish most substrate types, saving significant time and money. This degree of adhesion removes the need to pre-coat or varnish most substrate types, saving significant time and money.



*The information contained in this document is not intended as a substitute for undertaking appropriate testing for your specific use and circumstances. Neither Domino UK Limited nor any of Domino's group of companies is in any way liable for any reliance that you may put on this document with regards to the suitability of any ink for your particular application. This document does not form part of any terms and conditions between you and Domino, Legal Disclaimers v.1.0 February 2018 and Domino's Terms and Conditions of sale, and in particular the warranties and liabilities contained within them, shall apply to any purchase of products by you.*

## N610i Reel-to-reel

The Domino **N610i** in reel-to-reel format is the ultimate label press providing total flexibility for printing short runs or where multiple finishing and die cut changes downstream are required.

Available in 4, 5, 6 and 7 color options and capable of delivering consistent print quality day-in, day-out, the **N610i** delivers the highest production capabilities whilst offering total flexibility.



## N610i with near line finishing

Does your job structure suit a combination of in-line/offline finishing? The **N610i** has been designed to flexibly job-to-job work as a standalone reel-to-reel press or interfaced with industry leading digital finishing solutions.



Domino **N610i** with near line finishing from ABG



# N610i Hybrid

## Including the N610i Integration Module

Can be supplied as part of a fully integrated hybrid press working with partners globally.

You can include flexo stations before and after the **N610i** module as well as screen and foiling stations. It meets a wider range of product design needs, but still provides digital quick job change, and is well suited for multiple SKUs. High impact labels delivered in an efficient single process with white roll in, to final finished product output.



MPS EF SYMJET powered by Domino

Combined with the widest range of analog printing and finishing solutions, the Domino **N610i** Integration Module is rapidly becoming the de facto standard for converters looking for maximum flexibility and future-proofed production capabilities.



CEI Bossjet powered by Domino



ABG Digicon powered by Domino

Through the use of web buffers and **i-Tech WebRev**, even with in-line finishing or in hybrid formats waste associated with a substrate change or unplanned stoppage can be limited to 2m (6ft).

# Workflow

The Domino Workflow combines the industry standard Esko Digital Front End (DFE) with a high speed Domino Screen Pro screener and Job Definition File (JDF) server to provide a highly configurable workflow. It can be used in a fully automated mode, in a manual control mode and in combination with the Domino Application Programming Interface (API) for a unified hybrid press or in-line finishing solution.

The Domino Workflow is built to maximise the latest Adobe PDF Print Engine (APPE) and offers full support for the industry standard PDF/VT variable data printing (VDP) file format. It is also fully JDF/JMF compatible ensuring full integration with Management Information Systems (MIS).



## Workflow efficiency

The Domino Workflow in fully automated mode streamlines the workflow process, with increased job processing speed, removing the need for manual interventions and thus the risk of introducing errors.

Domino ScreenPro is available in two versions, Standard and High Speed (HS) for even faster processing. The HS version processes files in parallel to the Esko DFE, utilising the full processing power of the latest Domino Workflow server platform to deliver a near 2:1 rip-to-print ratio.

## Color Management Tools

The Esko DFE RIP and color management suite includes many advanced features such as a simple to use spot color refinement tool for accurately matching your customers' colors job after job.

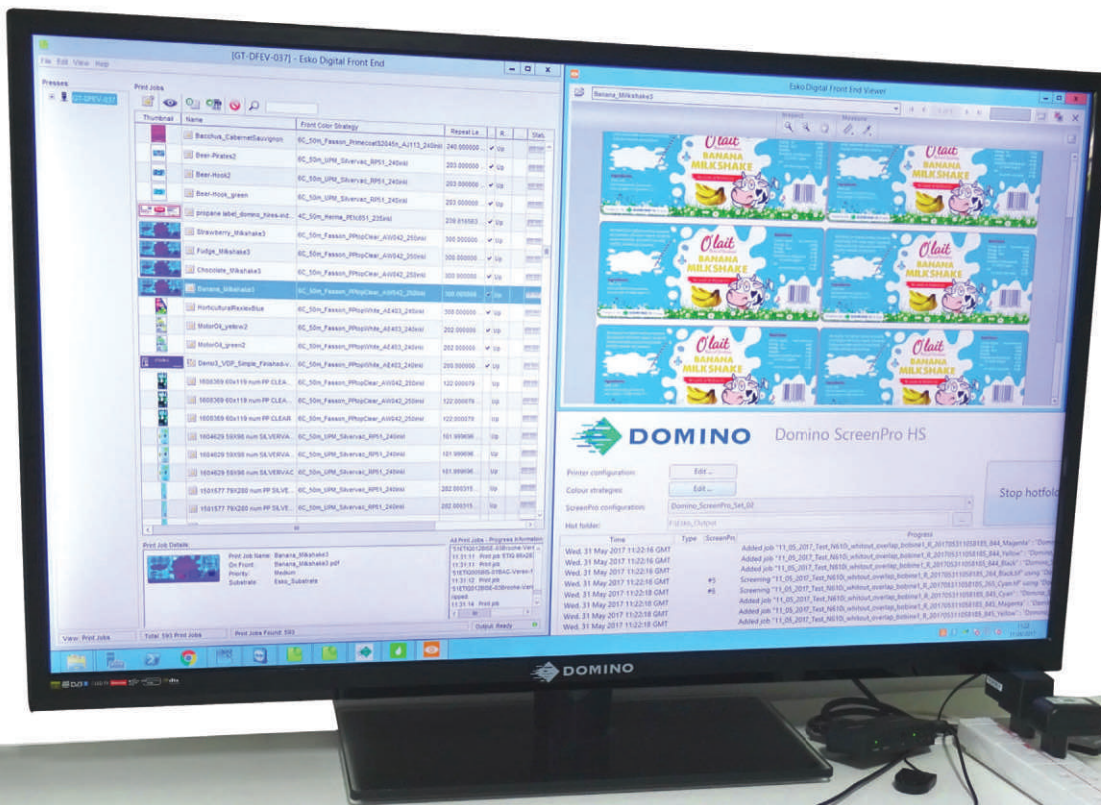





## Automation

Complete workflow automation removes the need for operator intervention and allows full integration into your Management Information System (MIS). It also provides seamless integration with the Esko Automation Engine via the Print-to-Digital Press Module, allowing upstream integration with designers and pre-press functions.

Regular jobs can be set up such that after order entry, the next touch point is selecting print at the **N610i** control desk.

## JDF/JMF Support

The Domino Workflow accepts industry standard JDF input files to drive the press and provides industry standard JMF feedback to the customer MIS system, providing job status and production information, including ink usage.

## Variable Data Printing

### Full Color VDP Workflow

With the increase in demand for product personalisation, Domino's full color variable data workflow printing not only allows variable text, barcodes and images to be printed, but also ensures the colors match your non-VDP content, even for 7 color printing.

The Domino Workflow offers support for variable data printing via three options according to the pre-press systems in place:

- ◆ Multipage PDF files
- ◆ PDF/VT files created in pre-press
- ◆ Support for Esko DeskPack VDP plugins for Illustrator allowing the expansion of VDP template files on the DFE using compatible Comma Separated Values (CSV) data files



# Take a closer look inside the **N610i**

## intelligent Technology

**i-Tech** components combine to create a system altogether more flexible and reliable.

### 1. Domino Inkjetting Assemblies

Proprietary Domino inkjetting assemblies incorporate Kyocera print heads that deliver consistent print results and higher reliability than any other press using similar technology.

### 2. Inkjet Engine

The **N610i** can be configured as either:

- 4 color CMYK
- 5 color CMYKW
- 6 color CMYKOV
- 7 color CMYKOVW

All with 333mm (13.11") print width and web width up to 340mm (13.4")

### 3. i-Tech CleanCap

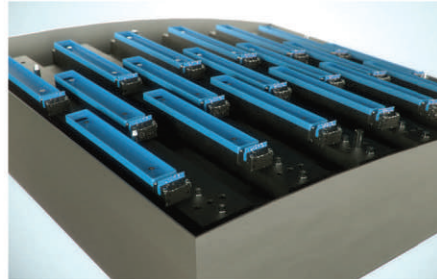

Automated print head cleaning and capping station ensures the highest print quality and productivity – all heads are cleaned within one minute.



<http://bit.ly/2gQsrCP>

### 4. i-Tech ActiFlow

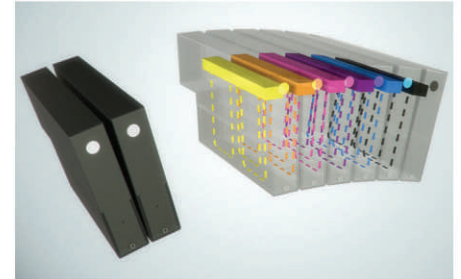

The ink circulation system keeps the ink continuously moving around the print head, maintaining a constant temperature and removing micro air bubbles, ensuring consistent print quality and reliability.



<http://bit.ly/2gN0oAo>

### 5. i-Tech StitchLink



Micro-motor controller technology ensures that all heads are positioned precisely, calibrated to print as one, enabling seamless print across the full web width.



<http://bit.ly/2vSgGIR>

### 6. Ink Cabinet

### 7. UV LED Pinning for CMYKOV and White

### 8. UV Curing GEW

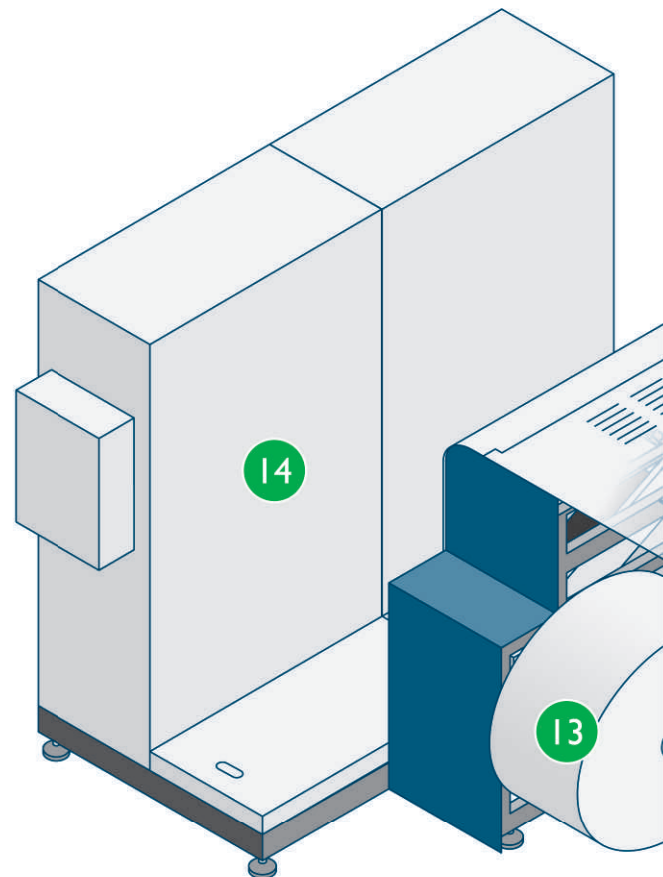





**9. Tension Control**

**10. Web Guide**

FMS

**11. Corona**

Vetaphone

**12. Web Cleaner**

Teknek dual sided web cleaner

**13. Unwind & Rewind**

Rolls up to 1000mm (40") diameter supported web

**14. Temperature controlled electronics cabinet**

**15. Splice Detection System**

Printing is paused and the print heads are automatically raised and then lowered after a poor splice has passed. The printing automatically continues in registration, wasting less than 3m of substrate

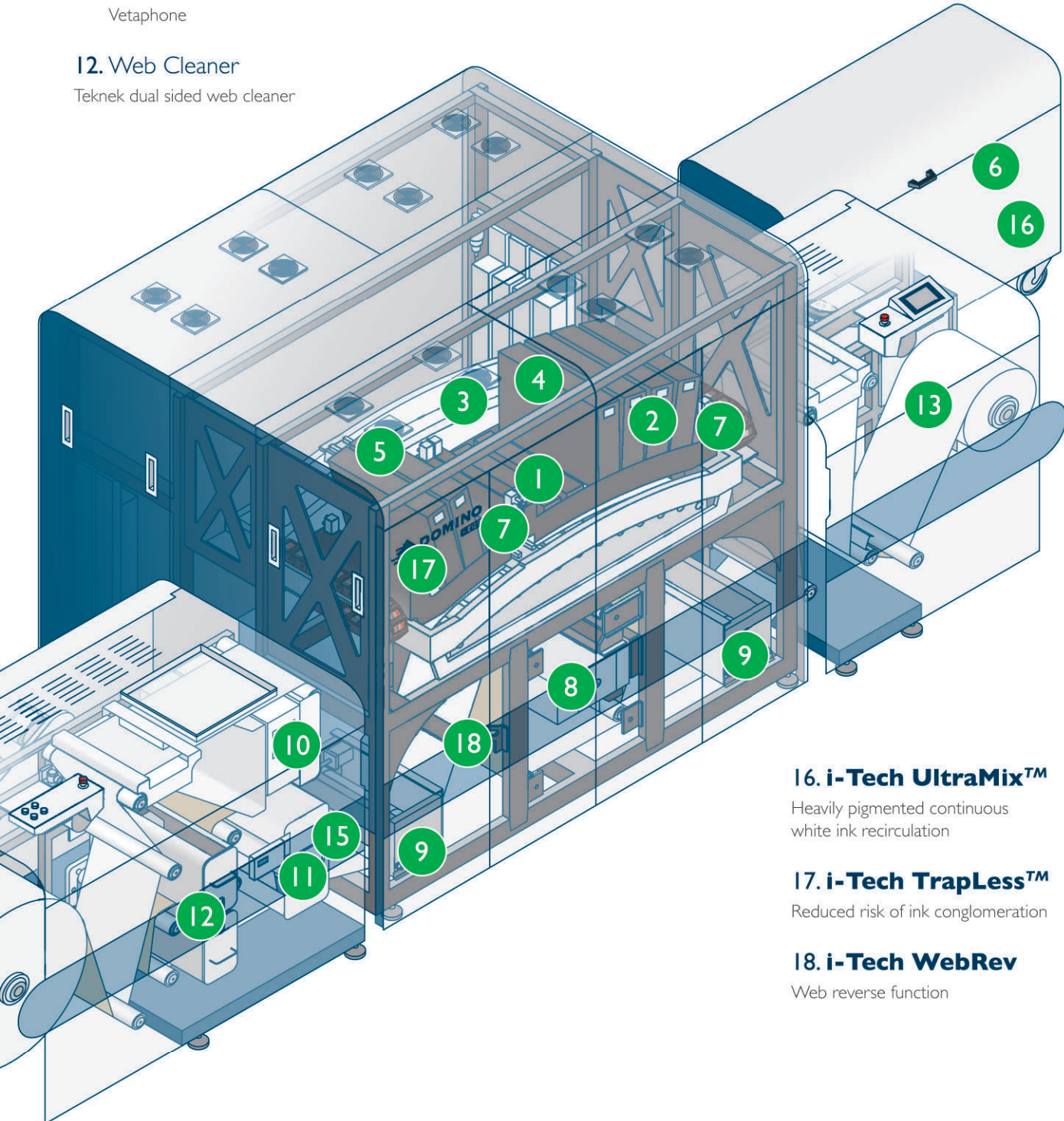

**16. i-Tech UltraMix™**

Heavily pigmented continuous white ink recirculation

**17. i-Tech TrapLess™**

Reduced risk of ink conglomeration

**18. i-Tech WebRev**

Web reverse function



Contact your local Domino representative to discuss how the Domino Digital Solutions Programme can help you grow your business.



## Domino Digital Solutions Programme

The Domino Digital Solutions Programme provides you with market leading training and consultancy services, helping you to identify how to unlock new growth potential whilst maximising the efficiency and output of your **N610i** digital printing press. With Domino you can be assured that we are with you 'every step of the way' and our Digital Solutions Programme is designed to provide you with tailor-made services that deliver significant value to your business.

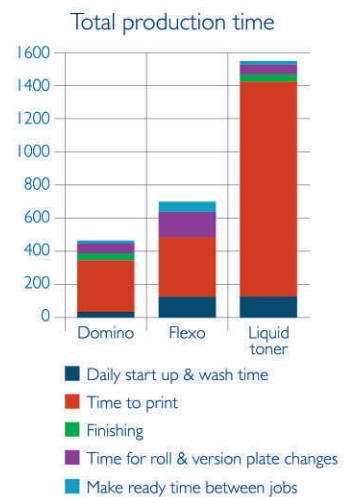
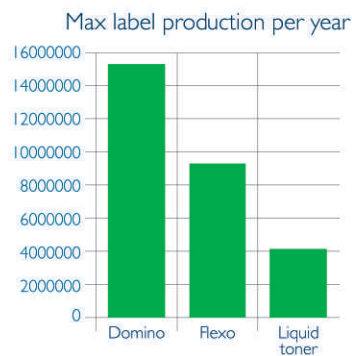
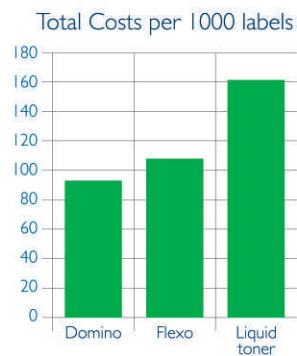
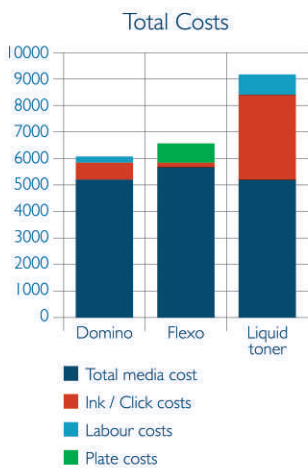



# About Domino

Founded in 1978, Domino Printing Sciences, has established a global reputation for the continual development and manufacture of coding, marking and digital printing technologies that meet the needs of its customers and set new industry standards in quality and reliability.

With over 1000 digital inkjet installations based on this product platform, Domino Digital Printing Solutions is the global industry leader.

Through a global network of 29 subsidiary offices and in excess of 200 distributors, the Domino Group operates in over 120 countries employing over 3,000 people worldwide with manufacturing facilities situated in UK, China, Germany, India, Switzerland, Sweden and USA.

On 11 June 2015, the Domino Group was acquired by Brother Industries Limited.

## Registered Office Details

Domino Printing Sciences plc  
Trafalgar Way  
Bar Hill  
Cambridge  
CB23 8TU  
United Kingdom  
Telephone: +44 (0)1954 782 551  
[www.domino-printing.com](http://www.domino-printing.com)



## Greener credentials

Domino's commitment and investment in sound environmental practices means we frequently exceed the increasingly demanding governmental, industry and company standards and regulations. We are committed to minimising the consumption of natural resources and energy and the creation of waste. Our inkjet printers are RoHS and WEEE compliant so that they are recyclable.

## N610i

The **N610i** requires no plates, no plate making process or associated materials for washdown purposes and with fewer curing lamps than a flexo press, it uses less energy resulting in reduced costs.

It can create very little media waste – this can be less than 2m (6ft) per job/substrate change and the capability to 'print-on-demand' results in less over-printing and reduced storage requirements.

The **N610i** is supplied with UV curable inks representing an efficient use of our natural resources. Although UV curable inks are chemicals and need to be used correctly, they offer significant environmental benefits compared to solvent alternatives. Solvent inks include up to 95% volatile solvents that evaporate into the environment and require regular print head cleaning. **N610i** UV curable inks contain 1% volatile solvents.

## Technical specification

### N610i

#### Technology

- Piezo Drop on Demand inkjet

#### Printing Speed

- Up to 50m/min (164ft/min) High Quality Mode
- Up to 70m/min (230ft/min) Rapid Mode

#### Image Resolution

- 600dpi native including 4 greyscales (nominal 1340dpi)

#### Image Format

- 333mm (13.11") maximum print width

#### Web Width

- 200mm (7.9") to 340mm (13.4")

#### Media Type

- Polyethylene, polypropylene and paper self-adhesive label stock
- Selected unsupported materials (films)

#### Inks

- UV90 & UV95 are available in UV curable Cyan, Magenta, Yellow, Black, Orange, Violet and White.

#### Unwind/Rewind

- 1000mm (40") diameter
- Maximum roll weight: 300kg (661lbs)
- Servo driven tension control
- Corona treatment module
- Web cleaning
- Web guide module

#### Workflow

- ESKO DFE
- Domino ScreenPro & ScreenPro HS

#### Central Print Module

- Anti-static control
- Up to 7 color print section
- UV LED pinning
- UV curing module

#### Options

- In-line finishing interface
- In-line inspection
- Variable data printing
- Chilled roller

#### Dimensions

- 5.614m (L) x 1.735m (H) x 1.925m (W)
- (1.0m minimum clearance required)
- 18.5ft (L) x 5.9ft (H) x 6.4ft (W)
- (3.3ft minimum clearance required)
- Ink cabinet: 1202mm (L) x 807mm (H) x 520mm (W) 48" (L) x 32" (H) x 21" (W)

#### Weight

- Unwind: 600kg (1323lbs)
- Printing section: Nominal 1500kg (3307lbs)
- Rewind: 400kg (882lbs)
- Power cabinet: 350kg (772lbs)
- Ink supply unit: 200kg (441lbs)

#### Services

- Single Drop, Three Phase Power, 400V +/- 6%
- Compressed air - one drop @ 6-8 bar (90-115psi), clean and dry

#### Environment

- Optimal temperature range 20-22°C (68-72°F)
- Maximum temperature range 20-25°C (68-77°F)
- Ink storage 20-25°C (68-77°F)
- Optimum humidity range 40-60%
- Dust controlled environment preferred

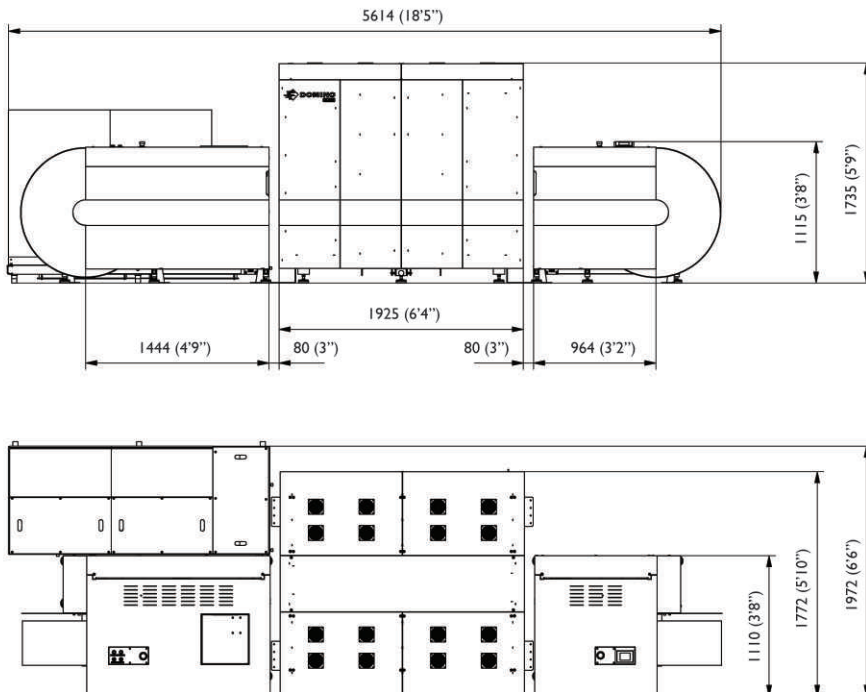

Dimensions in mm (feet/inches)

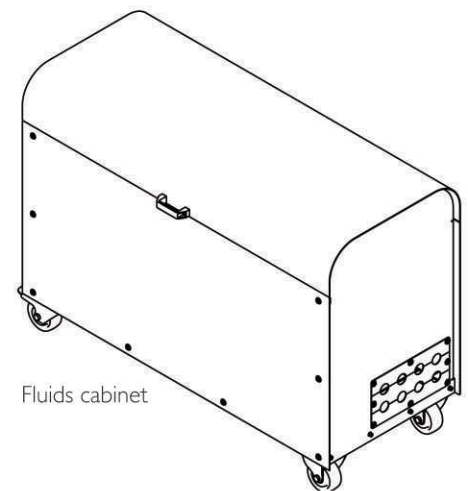

[www.N610i.com](http://www.N610i.com)

[www.domino-printing.com](http://www.domino-printing.com)